

600-660^{Q&As}

Implementing Cisco Application Centric Infrastructure - Advanced

Pass Cisco 600-660 Exam with 100% Guarantee

Free Download Real Questions & Answers **PDF** and **VCE** file from:

<https://www.pass2lead.com/600-660.html>

100% Passing Guarantee
100% Money Back Assurance

Following Questions and Answers are all new published by Cisco
Official Exam Center

- ⚙️ **Instant Download** After Purchase
- ⚙️ **100% Money Back** Guarantee
- ⚙️ **365 Days** Free Update
- ⚙️ **800,000+** Satisfied Customers



QUESTION 1

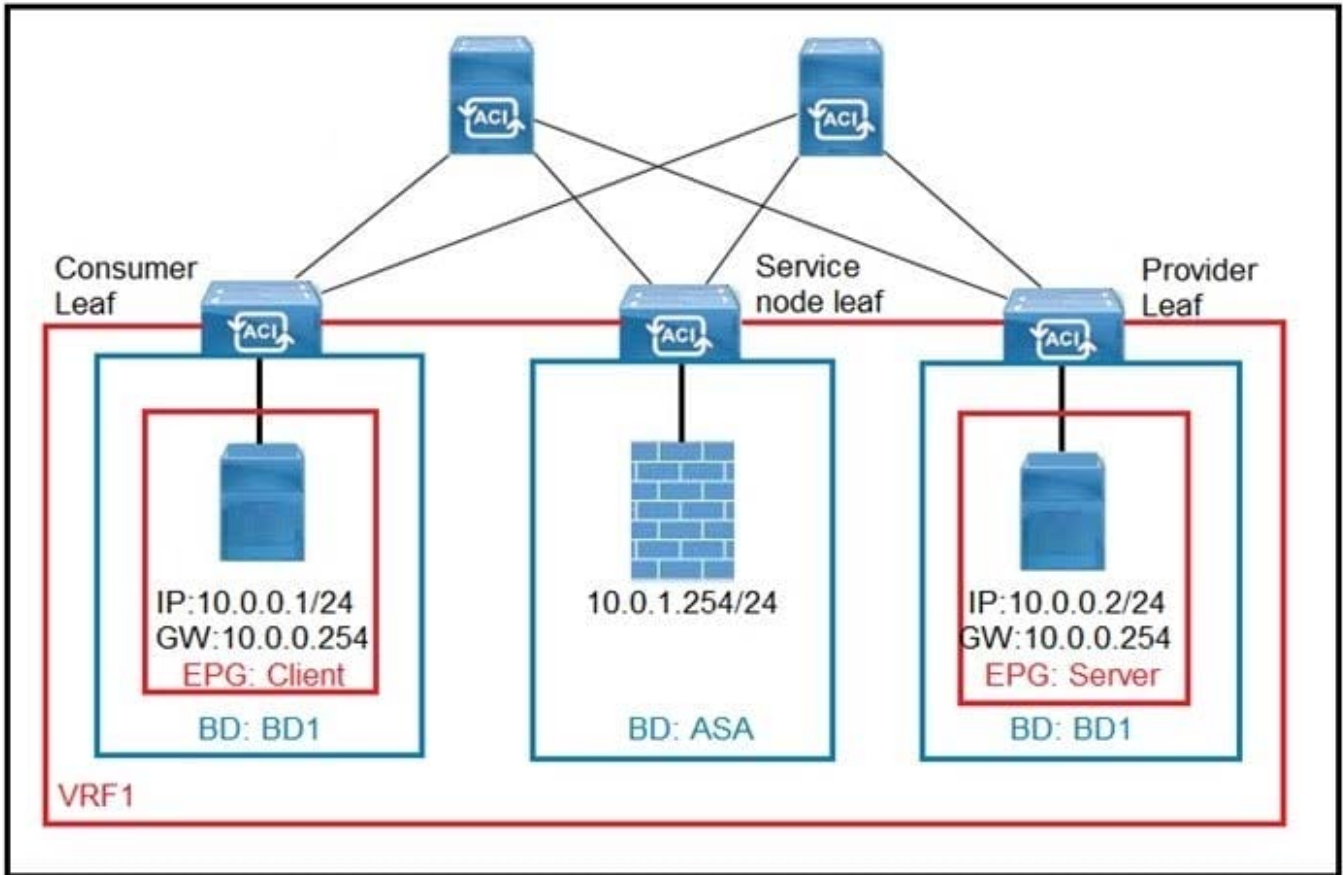

Refer to the exhibit. What must be configured in the service graph to redirect HTTP traffic between the EPG client and EPG server to go through the Cisco ASA firewall?

- A. contract filter to allow ARP and HTTP
- B. precise filter to allow only HTTP traffic
- C. contract with no filter
- D. permit-all contract filter

Correct Answer: A

QUESTION 2

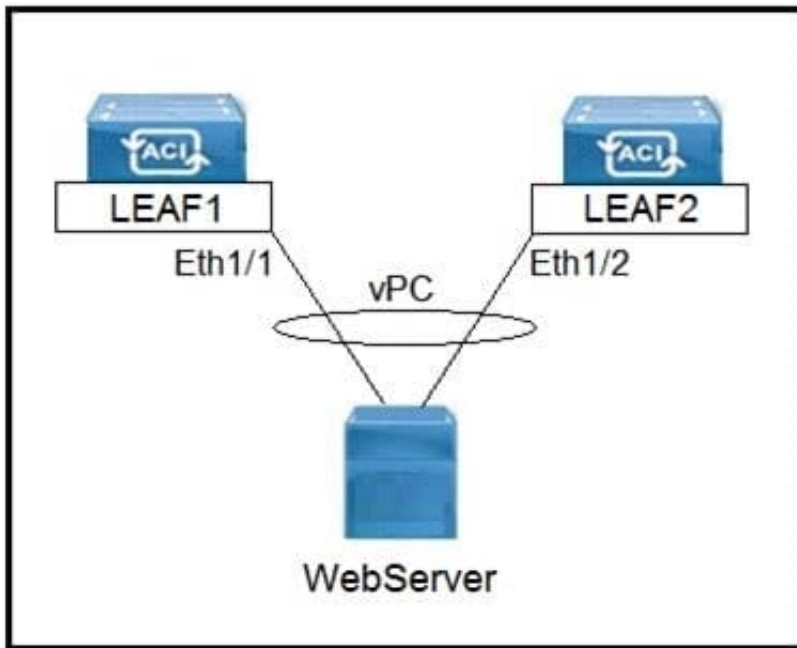

Refer to the exhibit. Which three actions should be taken to implement the vPC in the Cisco ACI fabric? (Choose three.)

- A. Select a common vPC interface policy group
- B. Select individual interface profiles
- C. Select common interface profiles
- D. Select individual switch profiles
- E. Select common switch profiles

Correct Answer: ABE

QUESTION 3

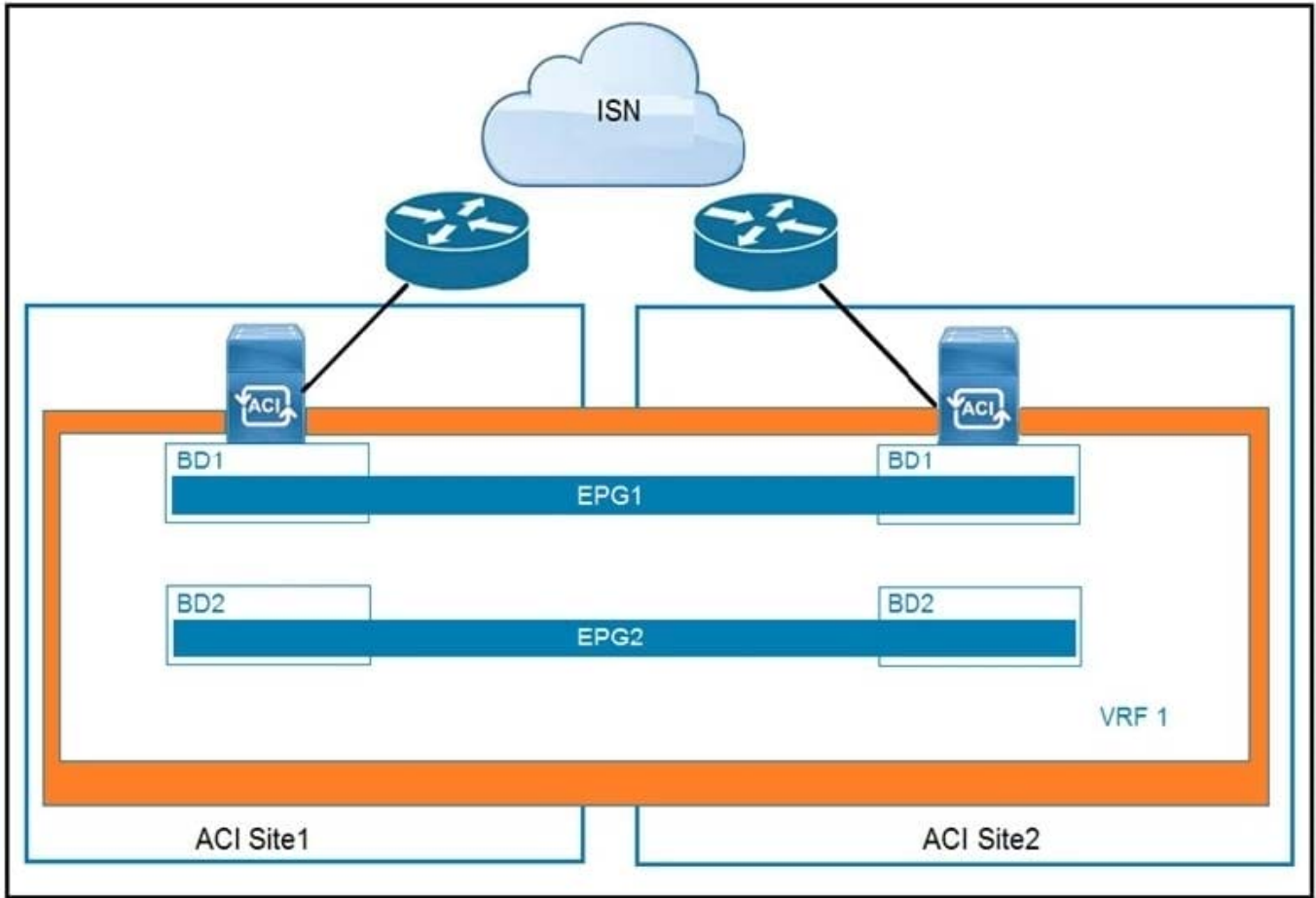

Refer to the exhibit. Which feature is available across sites if EPGs are stretched?

- A. active-active high-availability firewall clustering
- B. Layer 3 routing between sites
- C. Layer 2 flooding across sites
- D. live virtual machine migration

Correct Answer: B

Reference: https://www.cisco.com/c/en/us/td/docs/switches/datacenter/aci/aci_multi-site/sw/1x/fundamentals/b_Cisco_ACI_Multi-Site_Fundamentals/b_ACI_Multi-Zone_Fundamentals_chapter_01.pdf (6)

QUESTION 4

Create L4-L7 Devices

STEP 1 > Cluster

1. Cluster 2. Devices 3. Parameters

Name:

Device Package:

Context Aware: Multiple Single

Function Type: GoThrough GoTo L1 L2

Device Type: CLOUD PHYSICAL VIRTUAL

Cluster Management Interface

EPG:

Virtual IP Address:

Port:

Username:

Password:

Confirm Password:

Refer to the exhibit. A network engineer configures a Layer 4 to Layer 7 device for an outside routed firewall that is connected to POD-1 inside a Cisco ACI fabric that consists of two pods. All traffic from POD-1 or POD-2 that uses the L3Out should pass through the routed firewall. Which Function Type must be implemented in the service graph for POD-2 to use L3Out?

- A. GoThrough
- B. L1
- C. GoTo
- D. L2

Correct Answer: D

QUESTION 5

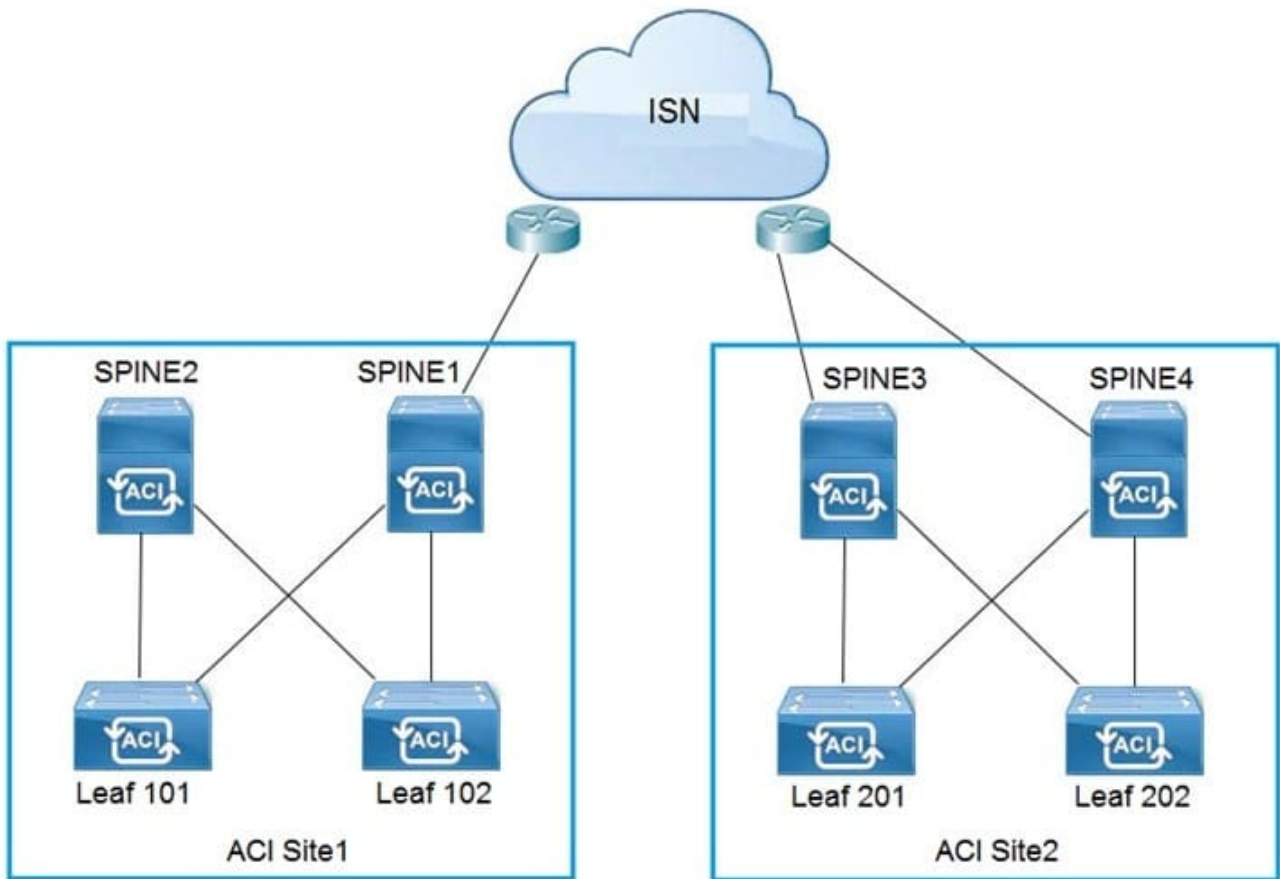

Refer to the exhibit. Which two configuration steps are required in ISN for Cisco ACI Multi-Site setup? (Choose two.)

- A. Connect Spine2 to ISN routers.
- B. Configure BIDIR-PIM throughout the ISN
- C. Increase ISN MTU to support the maximum MTU that is sent by endpoints
- D. Configure OSPF between spines and ISN routers
- E. Enable IGMPv3 on ISN routers

Correct Answer: DE

QUESTION 6

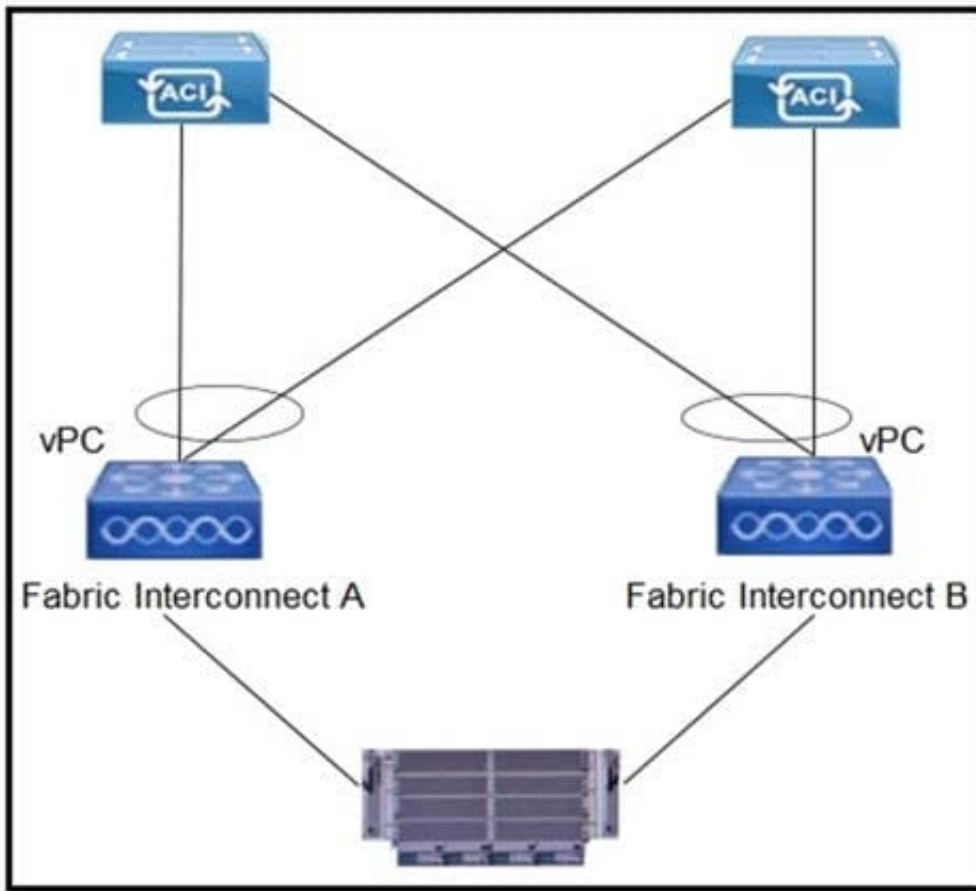

Refer to the exhibit. Which configuration mode must be selected for the VMM vSwitch Port Channel policy to avoid MAC flapping on the Cisco UCS FIs and Cisco ACI leaf switches?

- A. LACP Passive
- B. MAC Pinning
- C. LACP Active
- D. Static Channel ?Mode On

Correct Answer: B

QUESTION 7

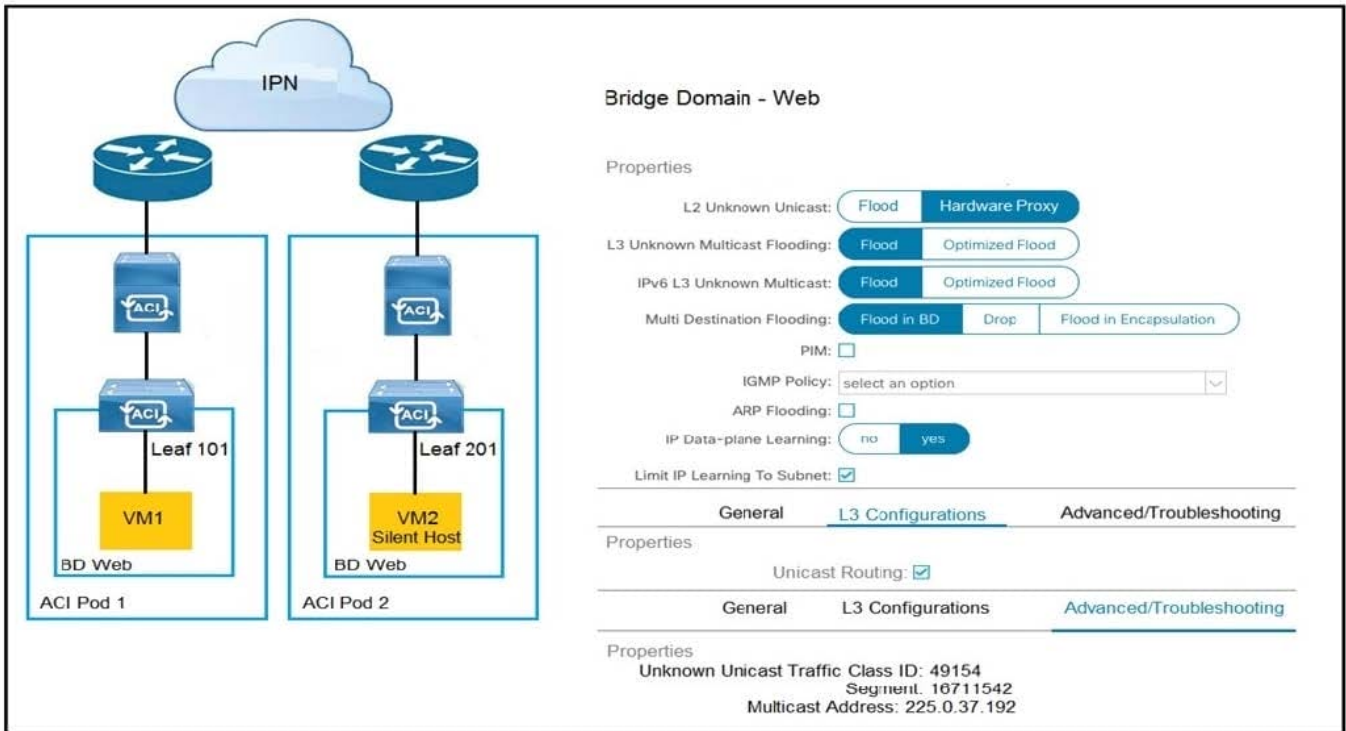

Refer to the exhibit. How is the ARP request from VM1 forwarded when VM2 is not learned in the Cisco ACI fabric?

- A. Leaf 101 forwards the ARP request to one of the proxy VTEP spines.
- B. POD1 spine responds to the ARP request after the POD1 COOP is updated with the VM2 location.
- C. Leaf 101 encapsulates the ARP request into a multicast packet that is destined to 225.0.37.192.
- D. Leaf 101 switch consumes the ARP reply of VM2 to update the local endpoint table.

Correct Answer: A

QUESTION 8

What are two characteristics of Cisco ACI interaction with MSTP? (Choose two.)

- A. A Cisco ACI leaf flushes all local endpoints in the received EPG when an MSTP TCN frame is received.
- B. A static path binding is required for native VLAN to carry the MST BPDUs in existing EPGs.
- C. Mis-cabling protocol is used to snoop the MSTP TCN packets.
- D. A dedicated EPG must be created for the native VLAN ID with static bindings toward the MSTP-enabled switches.
- E. The PVST simulation must be configured on external network switches to support MSTP.

Correct Answer: CD

QUESTION 9

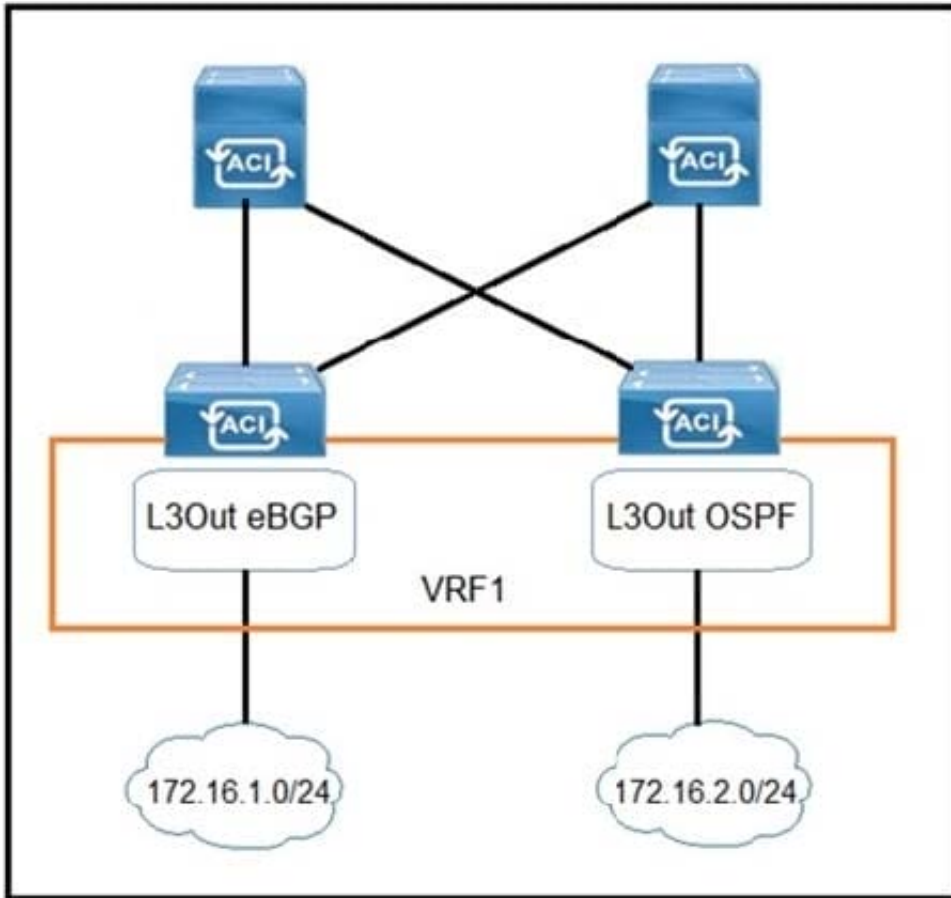

Refer to the exhibit. Which configuration must be implemented on L3Out EBGP to advertise out of the fabric 172.16.2.0/24 network that is learned from L3Out OSPF?

- A.
- B.
- C.
- D.

Correct Answer: A

QUESTION 10

An organization expands a Cisco ACI Multi-Pod from two to six pods and must ensure that the control plane scales. What should be configured in the IPN to ensure that BUM traffic is forwarded efficiently across the IPN?

- A. spine headend replication
- B. BIDIR-PIM
- C. MP-BGP

D. MSDP

Correct Answer: B

Reference: <https://www.cisco.com/c/en/us/solutions/collateral/data-center-virtualization/application-centric-infrastructure/white-paper-c11-737855.html>

[600-660 PDF Dumps](#)

[600-660 Practice Test](#)

[600-660 Braindumps](#)